



What Is This Module About?

Is there any idle land in your backyard? Would you like to grow your own vegetables so that you would not have to buy them from the market and therefore save money? Would you like to sell vegetables so that you can earn additional income? If you answered *yes* to one or more of these questions, then read on. This module can teach you how to grow your own vegetables. It is divided into three lessons:

Lesson 1 – *Soil Fertilization*

Lesson 2 – *Pest Control*

Lesson 3 – *Making Your Vegetable Garden*



What Will You Learn From This Module?

In this module, you will learn how to make and maintain your own vegetable garden. It will discuss the requirements of a good vegetable garden including soil fertilization and pest control methods.

After studying this module, you should be able to:

- ◆ discuss the advantages of using both organic and chemical fertilizers;
- ◆ name the types of chemical pesticides and explain their effects on the environment;
- ◆ describe alternative methods of pest control that do not use chemical pesticides;
- ◆ explain the importance of using both chemical pesticides and environment-friendly methods of pest control;
- ◆ prepare your own garden plot and grow healthy vegetables in it; and
- ◆ determine the right season for planting certain vegetables.



Let's See What You Already Know

Answer the following questions to determine what you already know about the topics that will be discussed.

- Look at the list of organisms that follow. Write **F** in the blank if the organism is friendly or harmless and **H** if the organism is harmful to plants.
 - _____ a. caterpillar
 - _____ b. lizard
 - _____ c. grasshopper
 - _____ d. earthworm
 - _____ e. locust
- What is the use of a seedling box?

- What are the three most important nutrients that plants need?
 - a. _____
 - b. _____
 - c. _____
- Tell whether the statement is correct or incorrect. Write **C** in the blank if the statement is correct, and **I** if it is not.
 - _____ a. Chemical fertilizers should not be used because they are bad for plants.
 - _____ b. Carbohydrates and fats are nutrients needed by plants.
 - _____ c. It is advisable to plant only one kind of vegetable in a piece of land all year round.
 - _____ d. Pesticides are harmful and should never be used in your garden.
 - _____ e. You can plant any kind of vegetable whenever you want.

Well, how was it? Do you think you fared well? Compare your answers with those in the *Answer Key* on page 46 to find out.

If all your answers are correct, very good! You may still study the module to review what you already know. Who knows, you might learn a few more new things as well.

If you got a low score, don't feel bad. This only means that this module is for you. It will help you understand important concepts that you can apply in your daily life. If you study this module carefully, you will learn the answers to all the items in the test and a lot more! Are you ready?

You may now go to the next page to begin Lesson 1.

Soil Fertilization

Did you know that plants have something in common with people? Plants can become malnourished and be infected by diseases and parasites, just like us. Therefore plants need proper and sufficient care and attention in order to grow healthy and bear much fruit.

In this lesson, you will learn the methods of maintaining and improving the health of vegetable plants. This lesson will focus on how to prevent plant malnutrition through soil fertilization. Healthy plants yield a rich harvest and have greater resistance against pests and diseases.

After studying this lesson, you should be able to:

- ◆ explain what fertilizers are;
- ◆ differentiate organic and chemical fertilizers and explain their importance to farming; and
- ◆ discuss the advantages of using both organic and chemical fertilizers in farming.



Let's Read

Mike is a young man from Calamba, Laguna. He wants to grow his own vegetable garden, but he doesn't know what to do. He decides to visit his uncle, Mang Juan, who is a successful farmer.

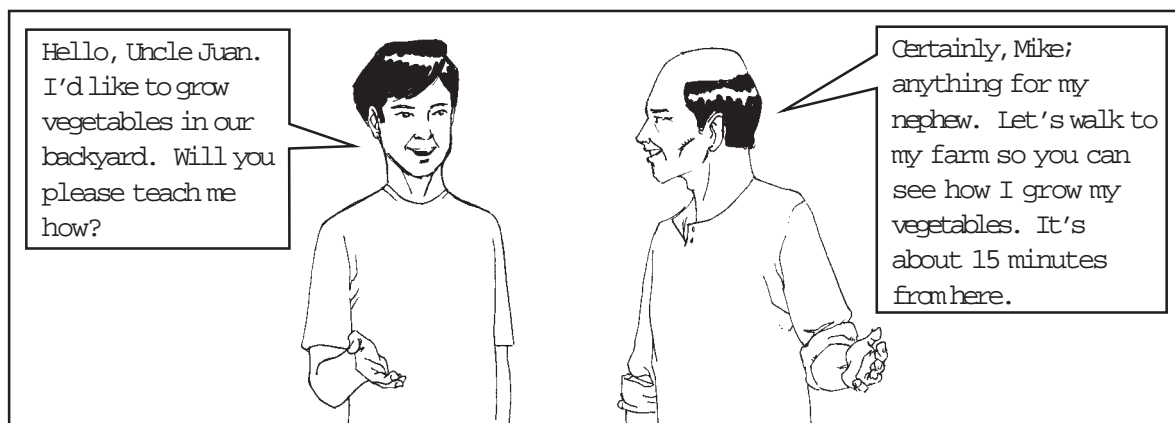

On the way, Mike and Mang Juan saw two farmers. They looked like they had a big problem ...

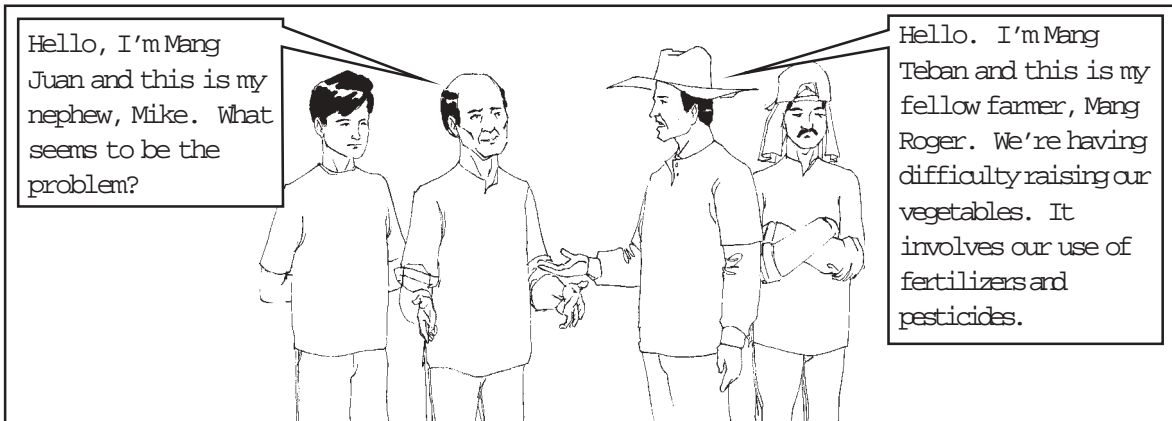

Mang Teban started to tell his problem first ...

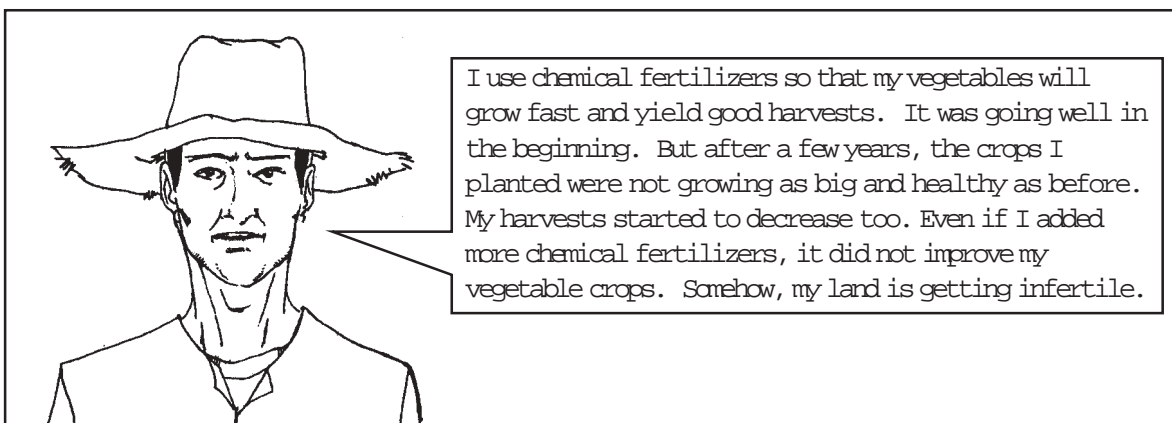

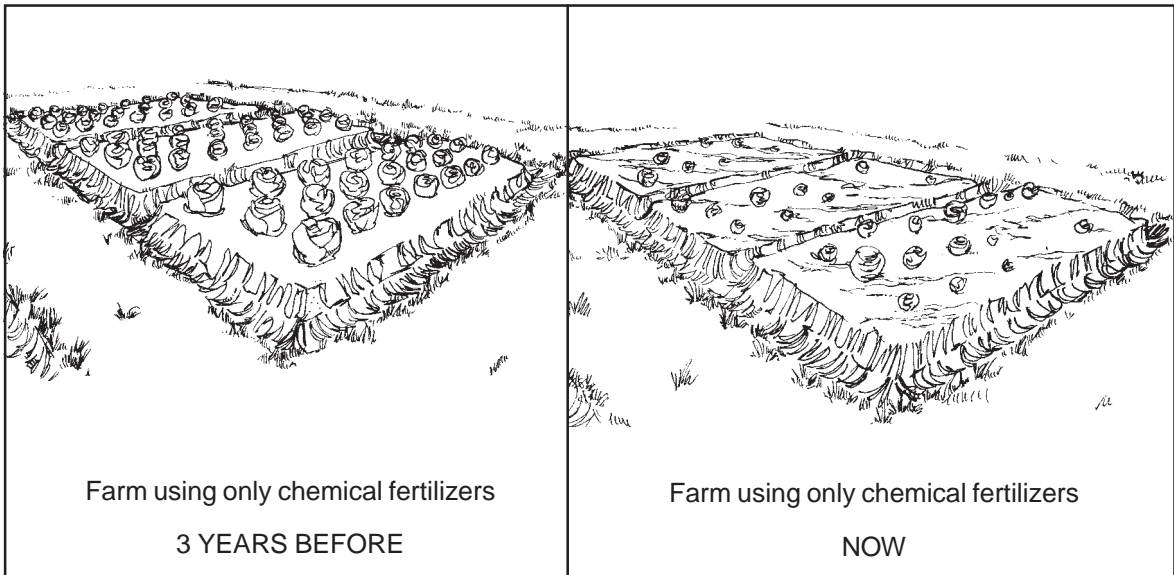

Mang Juan explained why Mang Teban encountered such a problem...

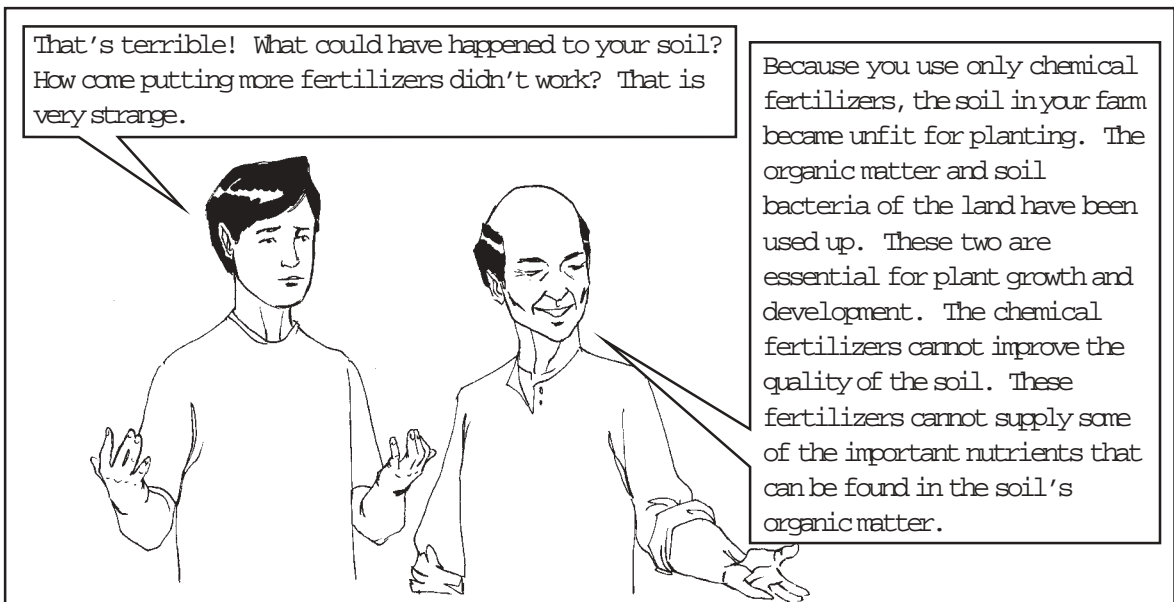

Mang Roger then explained his situation ...

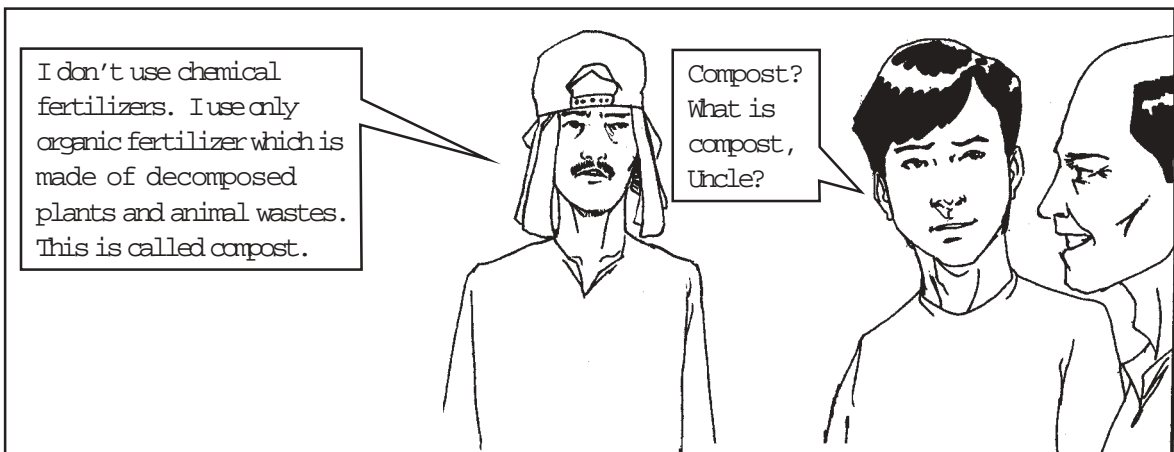

Compost or humus is made up of organic matter from dead plants and animals, animal manure and food leftovers. This organic matter is acted upon by soil bacteria and breaks down into compost. Compost provides some nutrients, like nitrogen, which are needed by the plants. It also improves the quality of the soil.



This is why I have used only compost as fertilizers. But why is it that some of my vegetable plants are not growing well and my harvests are not as rich as I've expected? What could be wrong?



That's because not all of the nutrients that the plants need are found in compost. Your plants may not be getting all the nutrients to make them grow healthy and produce more crops.

So what should Mang Roger and Mang Teban do to solve their problems?



They should use both organic and artificial or chemical fertilizers to make sure that the plants get all the nutrients they need. This would result in healthier plants and more harvests.



Let's Review

1. What are fertilizers?

2. What is compost?

3. Why did Mang Roger and Mang Teban have problems growing healthy plants even though they used fertilizers?

Compare your answers with mine:

1. Fertilizers are substances applied to the soil to provide nutrients for plants. There are two kinds of fertilizers: chemical fertilizers and organic fertilizers. Each kind provides certain nutrients needed by the crops.
2. Compost is made of decayed organic matter such as leaves, dead plants, animal manure, food leftovers and grass cuttings. It is used as an organic fertilizer that is rich in nitrogen and soil bacteria.
3. The two farmers, Mang Teban and Mang Roger, had problems growing healthy vegetables because they did not use both chemical and organic fertilizers on their crops. Their crops thus lacked some nutrients they needed to grow healthy and yield rich harvests. Since some nutrients can only be found in either of the two kinds of fertilizers, they should use both chemical and organic fertilizers for the crops to get all the needed nutrients.

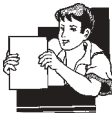

Let's Learn

There are two types of fertilizers:

1. **Chemical fertilizers**

These fertilizers contain elements or minerals that plants need for normal and healthy growth. The most important of these minerals are **phosphorus** and **potassium**.

The improper use of chemical fertilizers may contaminate bodies of water near the farm such as lakes, ground water, rivers or fish ponds. The substances in the fertilizer can harm or poison the fish and other animals that

live within or near the area. Excessive use of some artificial fertilizers can also harm the plants.

2. **Organic fertilizers**

Organic fertilizers are made of compost or humus. **Compost** is made through the decomposition of organic matter by soil bacteria. Organic matter may be made up of dead plants or animals, manure and/or food leftovers. Organic matter is rich in **nitrogen**.



Let's Try This

In your community, look for farmers who use organic fertilizers. Also look for farmers who use chemical fertilizers. Interview them about the fertilizers they use and the effects of these on their crops. You may also look at their crops to determine the effectiveness of the fertilizers they use.

You may ask them questions like:

1. What fertilizer/s do you use?

2. How long have you been using these fertilizers?

3. Have you considered using both organic and chemical fertilizers on your crops? Why or why not?

4. How much do you spend for fertilizers? Would the profits you earn from your improved harvests be more than the cost of fertilizers?

Keep their answers in mind as you read this lesson.

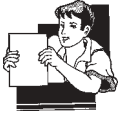

Let's Learn

Compost or humus is an important component of the soil. It has various functions:

- ◆ It holds and keeps the nutrients and minerals in the topsoil for the plants to use.
- ◆ It supports soil bacteria or microorganisms that maintain the plants.
- ◆ It holds water/ moisture in the soil.
- ◆ It improves the characteristics of the soil and allows air to penetrate the plant roots.

To make compost, dig a pit in the ground. Fill it with alternating layers of plant wastes (dead plants, grass cuttings, dead leaves, paper, sawdust, rotten fruits, etc.), animal wastes (animal manure) and soil. Water the compost pile and mix it using a shovel regularly. After about three months, your compost is ready to be used as fertilizer.



Let's Review

Make a step-by-step outline of the composting process by completing the sentences below.

1. Dig _____
2. Put some _____
3. Then add some _____
4. Add a layer of soil to the compost pile.
5. Alternate _____
6. Wait for about _____

Compare your answers with those in the *Answer Key* on page 46.

If you want to know more about composting, refer to the module entitled **Composting**. It has a detailed discussion on composts and how to make them.



Let's Try This

The combined use of organic and chemical fertilizers will provide plants with all the nutrients they need. Combining their use will result in an increased harvest of crops. It will also increase the resistance of the plants against diseases and pests.

This is the theory about fertilizers. Now that you know about it, let us test if it works. We will try planting corn seeds on different soils and see which soil can grow better plants. We will need the following materials:

- ◆ 4 plant pots or big empty cans
- ◆ sand
- ◆ corn seeds
- ◆ compost (organic fertilizer)
- ◆ chemical fertilizer (phosphorus and/or potassium fertilizers)
- ◆ hand shovel or old spoon
- ◆ nail
- ◆ hammer

1. If you do not have plant pots, use big empty cans. Using a nail and a hammer, punch holes in the bottom of the cans so that excess water can flow out when you water the plants.

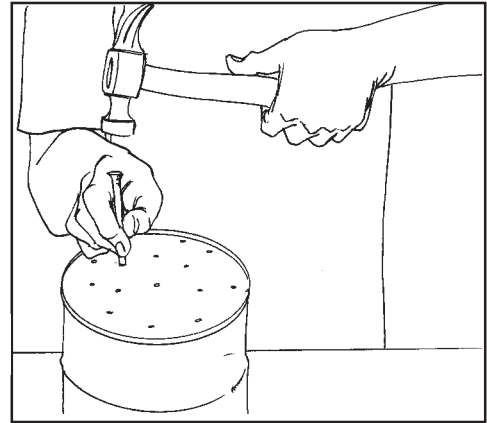

2. In the first pot, put equal parts of sand and compost using the hand shovel. Mix the compost and sand well. Fill the pot with the mixture until it reaches to about an inch from the mouth of the can or pot.

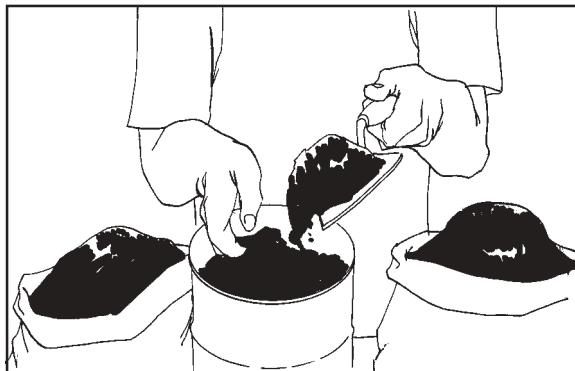

3. For the second pot, do the same and then add some chemical fertilizer.
4. For the third pot, fill it only with sand, then add some chemical fertilizer.
5. For the fourth pot, fill it only with sand.

- Plant corn seeds in each of the pots. Dig a small hole 1 inch deep and place a seed in the hole; then cover it. Water the pots every morning. Place the pots where there is plenty of sunshine.
- Wait for about two weeks until the corn seedlings start to sprout. Observe the growth of the corn plants in each of the pots.

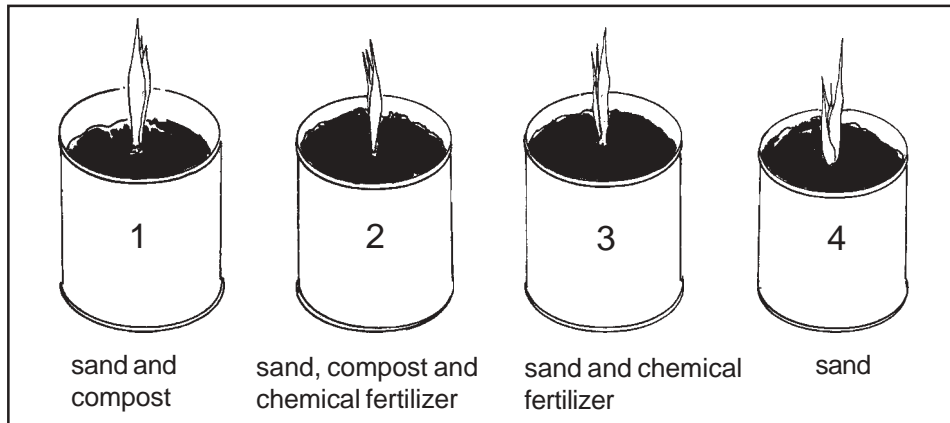

- Wait another two weeks and notice the differences in the growth and appearance of each corn plant.

Can you predict (tell in advance) which of the corn plants in the experiment above will grow well and healthy? Why?



Let's Study and Analyze

Try to guess what will happen to the four pots in the previous activity. Answer the following questions.

- Which pot do you think is the most complete in plant nutrients? Explain your answer.

- Which pot do you think is the most lacking in plant nutrients? Explain your answer.

- Why do you think the plant nutrients in pot 3 will be easily lost?

- Which corn plant will grow the healthiest? Which one will grow the least healthy? Explain your answer.

It may take you some time before you can see the results of the experiment. Or you may not be able to perform the experiment at all. So look at the picture below. It will give you an idea of what to expect when the corn plants grow.

The results of the activity should be similar to what is shown in the picture.

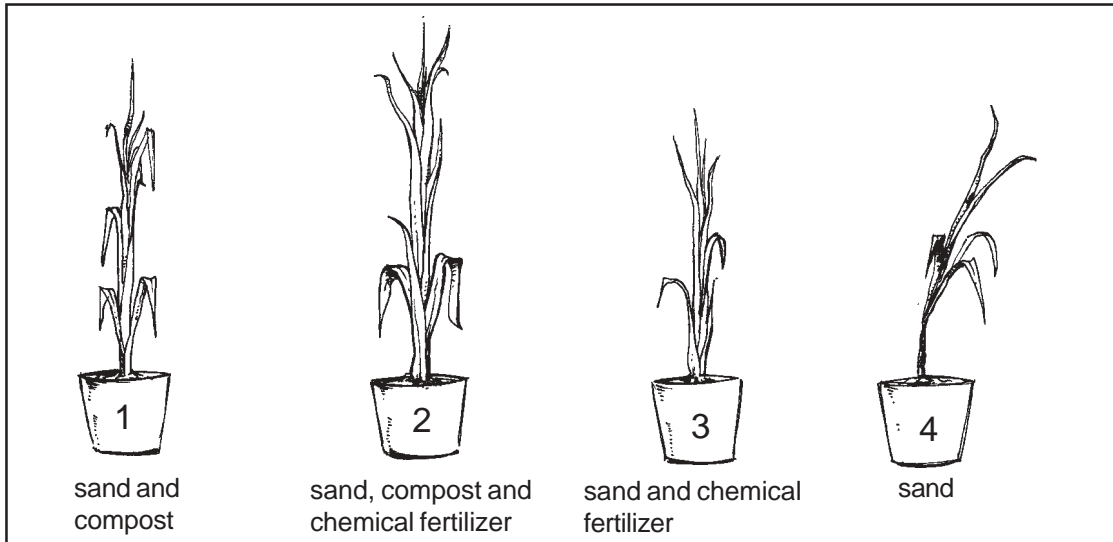

Compare your answers with those in the *Answer Key* on page 47.



Let's Read

Let's continue with the story about the problem of Mang Teban and Mang Roger ...

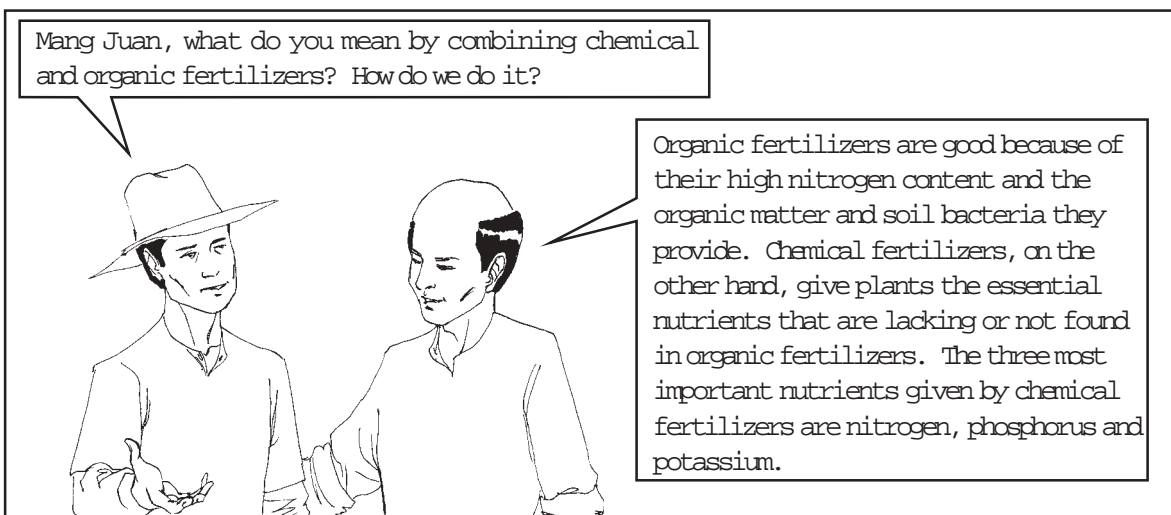

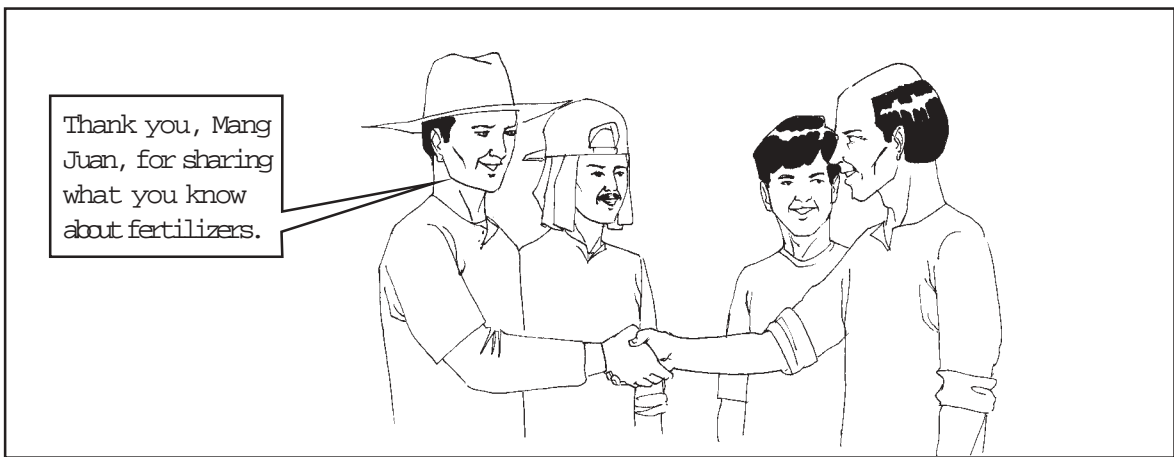
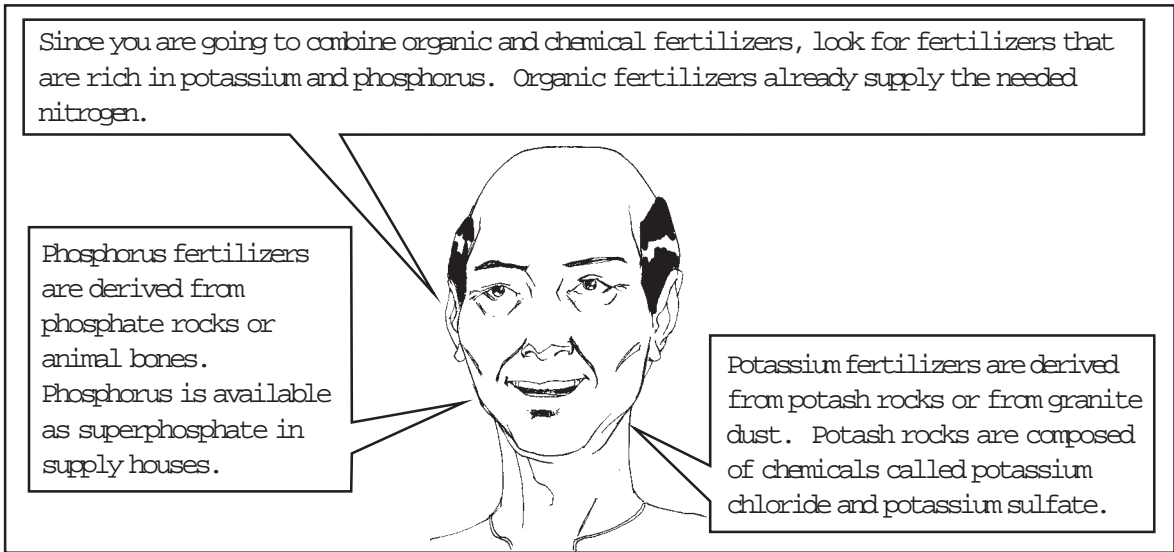

Let's Review

1. According to Mang Juan, what kind of chemical fertilizers should be combined with organic fertilizers? Explain your answer.

2. Where can the plant nutrients potassium and phosphorus be derived from?

3. Chemical fertilizers can provide the nutrients nitrogen, phosphorus, and potassium which are the three major nutrients that plants need. Is it therefore safe to say that organic fertilizers are no longer needed when chemical fertilizers are used? Explain your answer.

Compare your answers with those in the *Answer Key* on page 47.



Let's See What You Have Learned

We have come to the last part of the lesson. We will now see how much you have understood from our discussions. Answer the following questions. Good luck!

1. Give the disadvantages of using only chemical fertilizers on the crops for soil fertilization. (5 points)

2. Explain how to make compost. (5 points)

3. How does compost fertilize the soil? (5 points)

4. What can you say about farmers who strongly support organic farming (farming using only organic fertilizers)? Do you agree with them? Why or why not? (5 points)

That wasn't so hard, was it? Now let's check how well you performed in the test. Compare your answers with those in the *Answer Key* on pages 47–48. If your test score is:

- 18 – 20 Excellent! You have understood the lesson well. You may now proceed to the next one.
- 13 – 17 Good! Study only the items in the lesson that you did not get right.
- 7 – 12 You should review the parts of the lesson you did not understand.
- 0 – 6 You should study this lesson again.

Now that you have understood one of the requirements for maintaining healthy plants—soil fertilization—let us continue with our study. Read the lesson summary that follows, then turn to the next page for Lesson 2.



Let's Remember

- ◆ Fertilizers replenish the depleted nutrients in the soil and help increase crop harvests.
- ◆ Organic fertilizers improve the soil's characteristics and provide plants with the nutrient nitrogen.
- ◆ Chemical fertilizers supply the plants with nutrients lacking in organic fertilizers. They can supply potassium, phosphorus and other minerals that plants need.
- ◆ The use of both organic and chemical fertilizers will provide the plant crops with most of the essential nutrients they need. Sufficient supply of plant nutrients will make the plant crops healthier and produce richer harvests.

Pest Control

You have learned in the first lesson how to fertilize the soil to improve the health of plants. But fertilization is not enough to keep your plants healthy. Pests can infest and destroy the plants. They can also cause plant diseases. This can lead to great losses in crop harvests.

In this lesson, you will learn how to manage and control pests that damage and harm plants. Also, you will deal with some concerns and issues regarding the use of chemical pesticides.

After studying this lesson, you should be able to:

- ◆ explain what pesticides are;
- ◆ discuss the types of pesticides used and their effects on the environment;
- ◆ identify the environment-friendly methods of pest control; and
- ◆ explain the advantages of the integrated pest control approach.



Let's Read

Let us continue with the story of Mike and his Uncle Juan as they talk with the two farmers, Mang Teban and Mang Roger.

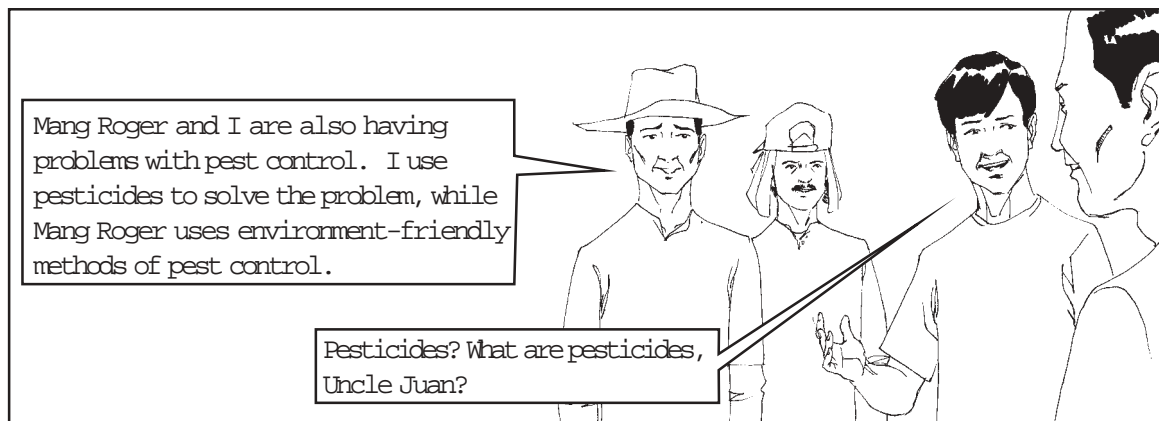

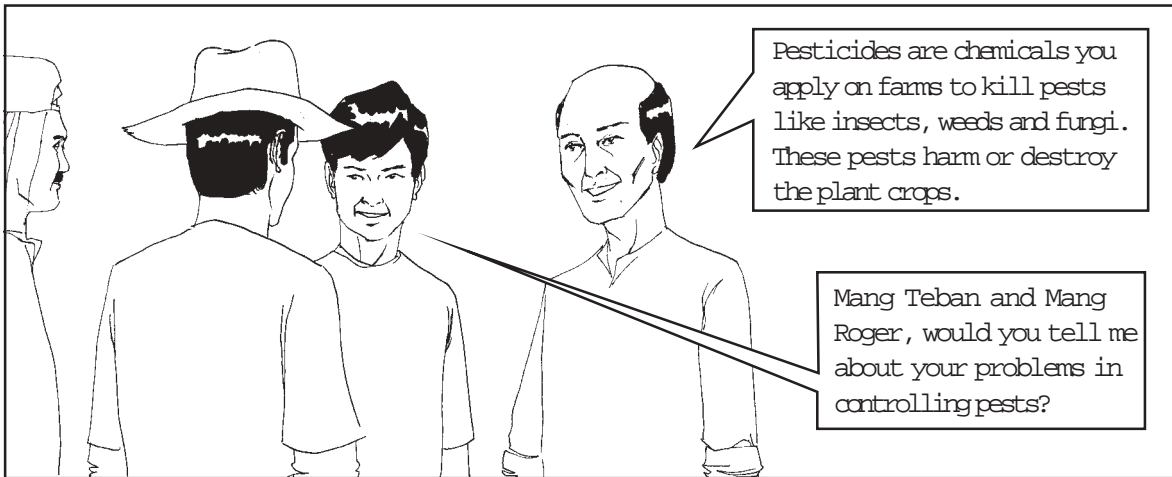

Pesticides are chemicals you apply on farms to kill pests like insects, weeds and fungi. These pests harm or destroy the plant crops.

Mang Teban and Mang Roger, would you tell me about your problems in controlling pests?

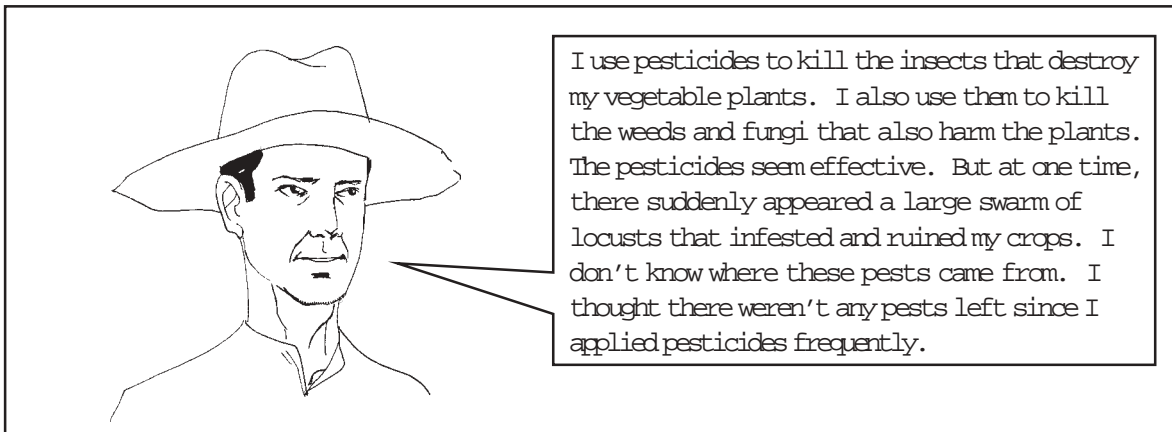

I use pesticides to kill the insects that destroy my vegetable plants. I also use them to kill the weeds and fungi that also harm the plants. The pesticides seem effective. But at one time, there suddenly appeared a large swarm of locusts that infested and ruined my crops. I don't know where these pests came from. I thought there weren't any pests left since I applied pesticides frequently.

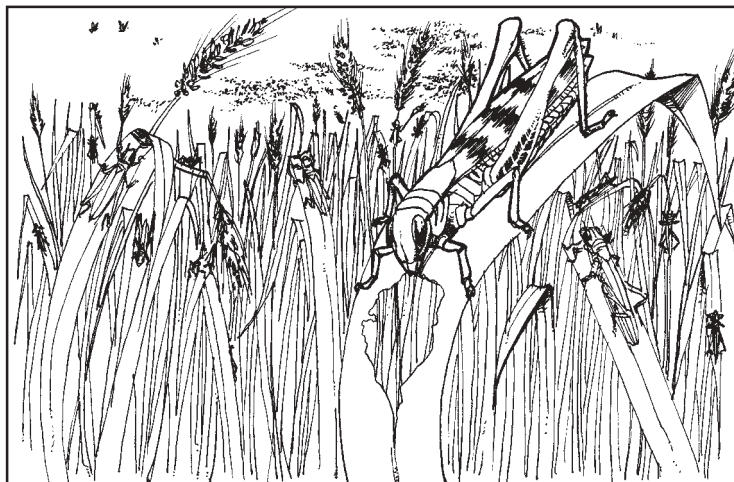

And lately, my son started to get sick. The doctor says he has high levels of toxins (poisonous substances) inhaled or ingested (taken in) from the pesticides on the vegetables.

I'm sorry to hear that, Mang Teban. I wonder how all these could have been prevented?

Mang Teban should minimize his use of pesticides. The chemical poisons applied on the farm can be carried over to the vegetable harvests that people eat. Also, the chemical poisons can be carried by the wind or by bodies of water nearby. This can poison both humans and animals.



But how can you explain the large swarm of locusts in spite of Mang Teban's use of pesticides?

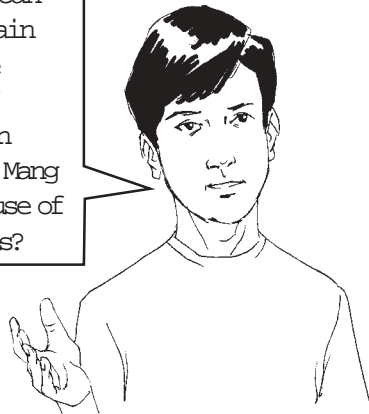

Some insecticides kill all types of insects, whether they are pests or good insects. The pests are the ones that destroy or harm the plant crops. The good insects are those that feed on the insect pests.



Since the pesticides also kill the good insects, their number will greatly decrease. This will reduce the natural enemies of the pest insects. The insect pests will therefore reproduce in great numbers and develop into swarms that can destroy whole farms. Also, some pests develop resistance against pesticides, making it more difficult for the farmers to control them.



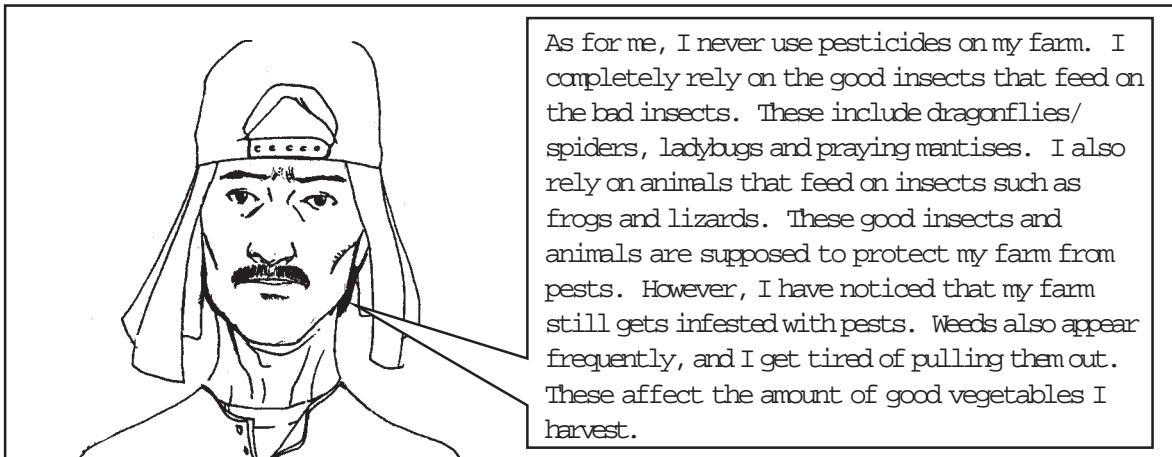

As for me, I never use pesticides on my farm. I completely rely on the good insects that feed on the bad insects. These include dragonflies/spiders, ladybugs and praying mantises. I also rely on animals that feed on insects such as frogs and lizards. These good insects and animals are supposed to protect my farm from pests. However, I have noticed that my farm still gets infested with pests. Weeds also appear frequently, and I get tired of pulling them out. These affect the amount of good vegetables I harvest.

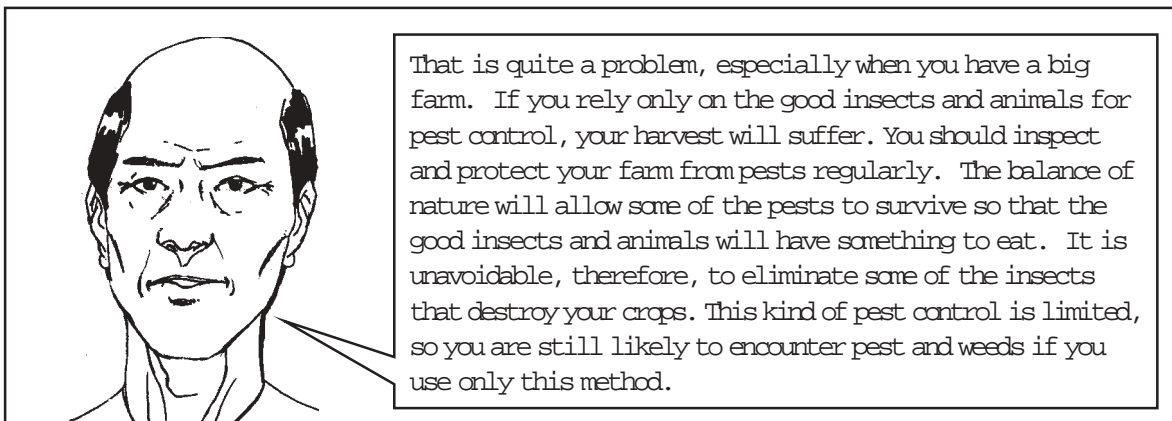
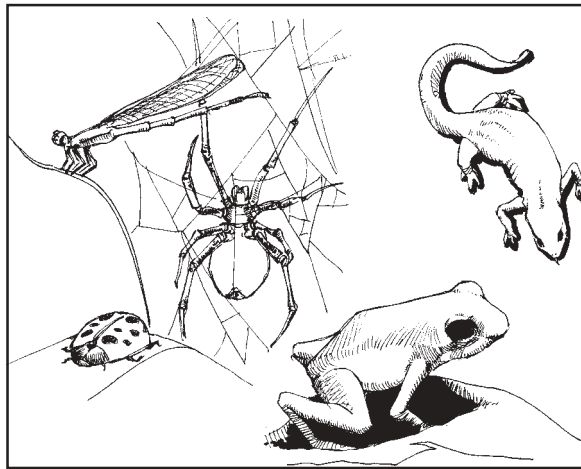

That is quite a problem, especially when you have a big farm. If you rely only on the good insects and animals for pest control, your harvest will suffer. You should inspect and protect your farm from pests regularly. The balance of nature will allow some of the pests to survive so that the good insects and animals will have something to eat. It is unavoidable, therefore, to eliminate some of the insects that destroy your crops. This kind of pest control is limited, so you are still likely to encounter pest and weeds if you use only this method.

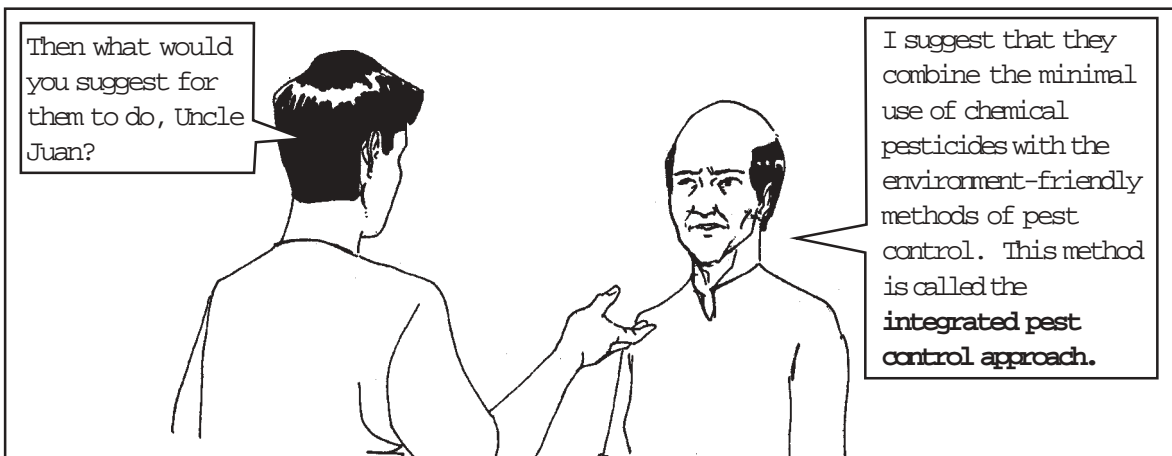

Then what would you suggest for them to do, Uncle Juan?

I suggest that they combine the minimal use of chemical pesticides with the environment-friendly methods of pest control. This method is called the **integrated pest control approach**.



Let's Review

1. Explain why a large swarm of insect pests still invaded Mang Teban's farm even when he used chemical pesticides.

2. What are some good insects and animals that help control pests in Mang Roger's farm? Enumerate at least five.

3. Why isn't it enough to use friendly animals and insects to control pests in Mang Roger's farm?

Compare your answers with those in the *Answer Key* page 48.

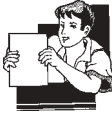

Let's Learn

Pests that harm plants can be classified into three groups:

1. **Harmful insects**—are insects that damage or harm plant crops.
2. **Weeds**—are harmful plants that grow with the planted crops and compete with them for nutrients in the soil or bring plant diseases to the farm.
3. **Fungi**—are parasitic organisms that infest plants. They damage and infect parts of the plants and may eventually kill the plants. Fungus infection on the farm can severely reduce crop harvest.

There are two major techniques for controlling pests: the use of **chemicals** and the use of **environment-friendly methods**.

In the chemical control of pests, the use of pesticides is employed. Pesticides are poisonous chemicals that are used to kill pests. There are three types of pesticides:

1. **insecticides**—chemicals used to kill insects
2. **herbicides**—chemicals used to kill weeds
3. **fungicides**—chemicals used to kill fungi

There are three types of chemical pesticides according to how long these chemicals decompose into harmless substances:

1. **Nonpersistent Pesticides**—These are pesticides that decompose rapidly into harmless substances. Examples of this type of pesticide are the organophosphate insecticides. Organophosphates are highly poisonous, but they decompose more rapidly than the other insecticides. They don't leave harmful residues on vegetable harvests or on the farm. Other examples of nonpersistent pesticides are chemicals from plant extracts such as nicotine.
2. **Persistent Pesticides**—These are pesticides that do not decompose easily and may leave harmful residues for up to 20 years. Since these chemicals do not decompose easily, harmful chemicals can accumulate on farmlands with the regular application of these pesticides. These harmful chemicals may contaminate ground water and other bodies of water near the farm. Examples of these pesticides are DDT, dieldrin, endrin and heptachlor.
3. **Permanent Pesticides**—These are pesticides that contain heavy metals such as lead, mercury and arsenic. These chemicals do not decompose into harmless substances. They accumulate in the bodies of animals and humans permanently. When the levels of heavy metals are high in an organism's body, certain diseases may develop that may even cause death.

Persistent and permanent pesticides should be used cautiously and minimally. These pesticides cause long-term damage to the environment. They may contaminate rivers, lakes, ground water and even the vegetables and fruits we eat. They can even accumulate on humans from pesticides inhaled or from the fruits and vegetables eaten. Thus, it is safer to use nonpersistent pesticides.

For a more comprehensive discussion on the use of chemical pesticides and its effects on the environment, please refer to the module entitled *Pesticides*.



Let's Think About This

1. Explain why it is safer to use nonpersistent pesticides than permanent and persistent pesticides.

2. Why can't we use one type of pesticide to eliminate all kinds of pests?

Compare your answers with those in the *Answer Key* on page 48.

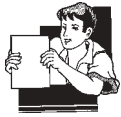

Let's Learn

Environment-Friendly Methods of Pest Control

There are a number of methods used in controlling pests that do not involve the use of chemical pesticides. Read about the mechanical, cultural and biological methods of pest control below. As you read, ask yourself: *Will such methods always work? Why or why not?*

1. Mechanical Control—This method involves the physical or manual removal of pests from the farm.

◆ **The use of nylon nets**—This method involves the use of nets with small holes to cover your plant seedlings for the first 30 to 40 days of planting. This will prevent insects from harming the seedlings in their critical stages.

◆ **Roguing or pruning**—This involves the removal and burning of plant parts that are infected with pests or diseases. This practice will help prevent the spread of pests and diseases in your farm.

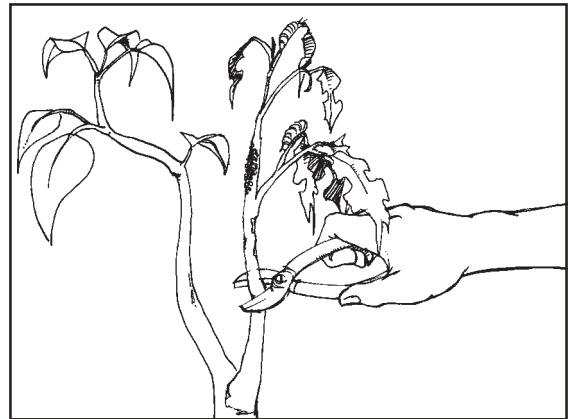

◆ **Manual removal**—This method involves removing insect pests, weeds or infected plants with your hands. You should inspect your farm/garden regularly for these pests.

◆ **Pest traps**—Some farmers use light traps. These traps use light to lure insects. Some traps make use of insect hormones or chemicals that attract male insects toward the trap.



Let's Think About This

What do you think are the limitations of the mechanical methods of controlling pests? Are they effective on both small and large farms? Explain your answer.

Compare your answers with those in the *Answer Key* on page 49.

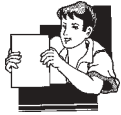

Let's Learn

Here is another set of environmental friendly pest control techniques commonly used by farmers.

These methods are.

2. Cultural Control—This method involves the control of pests through good soil and plant management.

- ◆ **The use of fertilizers**—The combined use of organic and chemical fertilizers on plant crops will make crops healthy and resistant to pests and diseases.
- ◆ **Planting pest-resistant crop varieties**—By planting pest-resistant crop varieties, pest infestations and diseases can be greatly reduced. Ask seedling banks or local government units about the availability of pest resistant crop varieties. Usually, native crops such as cucumber, *saluyot* and sweet potato are more resistant to pests and diseases than modern/imported vegetables.
- ◆ **Intercropping with aromatic herbs**—Aromatic herbs repel many insect pests that ruin your regular crops. By planting these aromatic herbs with the regular crops, you will greatly reduce pest infestations on your farm. Examples of aromatic herbs are onion, garlic, parsley and ginger.
- ◆ **Companion cropping**—There are different plants that can be planted together. They are called companion plants. These plants complement each other because they do not compete with each other for soil nutrients. Most companion crops repel the pests of their companion crop. Therefore, each of these crops protect one another from pest infestation. However, there are antagonistic crops or crops that should not be placed together in one seedbed. Antagonistic crops compete with each other for nutrients in the soil and attract the same kind of pests. Look at the table below for examples of companion and antagonistic crops.

Vegetable	Companion Crops
onion	lettuce, beet, tomato
cucumber	corn, radish, eggplant
sweet potato	corn, cassava, tuber
lettuce	carrot, radish, cucumber
potato	garlic, beans, corn

- ◆ **Crop rotation**—This method employs the planting of a certain crop at a time, one after another, until you complete the cycle. Then you should begin again with the first crop. The plants involved in the rotation usually provide the nutrients and conditions needed by the next crop to be planted. For example, onions may repel insect pests that infest tomato plants.

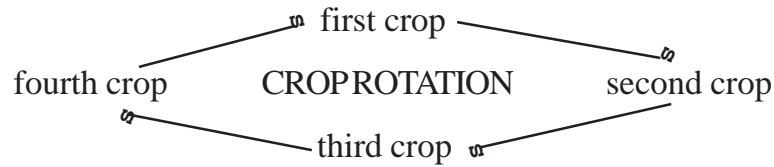

Example:

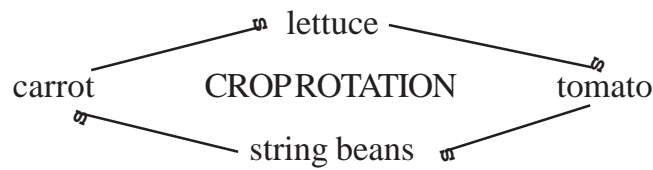

- ◆ **Deep plowing**—This method involves the deep plowing of the soil to kill the weeds. The weeds deprive the plant crops of soil nutrients. They may also compete for sunlight and bring plant diseases that may harm the crops.



Let's Think About This

Answer the questions below.

1. How can the use of fertilizers help control pests?

2. “Different plants can *always* be planted together to repel pests.” Give your reaction to this statement.

Compare your answers with those in the *Answer Key* on page 49.

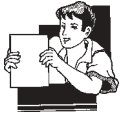

Let's Learn

Biological Control Methods

The following method is the most recent technique used for controlling pests. How effective do you think it is?

3. **Biological Control**—This method makes use of friendly organisms that eat, kill or control pests.

- ◆ Provide an environment suitable for lizards, frogs and other insect-eating animals to control the population of insect pests on your farm.



- ◆ Breed friendly insects. Some farmers hatch the eggs of some friendly insects and breed them. These insects include praying mantises, spiders, dragonflies and ladybugs. These should be released on the farm when they are old enough. They will eat the pests that destroy the crops.

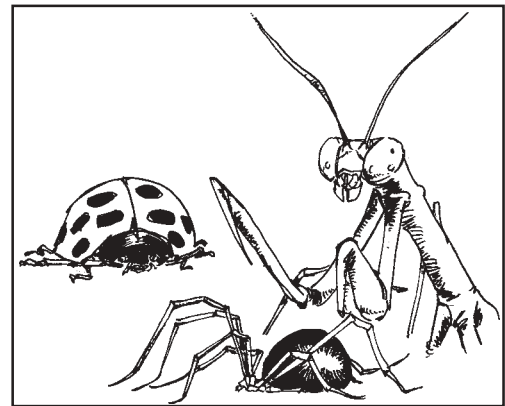

- ◆ **Microbial agents**—Some microorganisms such as bacteria, fungi or nematodes are parasites of insect pests. These microorganisms are harmless to man and domestic animals. Some laboratories produce them in many numbers and sell them to farmers. The farmers apply them on the farm to control the population of insect pests.
- ◆ **Sterile insect technique**—In other countries, some male insect pests are sterilized by exposing them to harmful gamma radiation. These insects won't be able to reproduce. Once these sterile insects are released on the farms, they will look for a mate. They will try to reproduce but they will not be able to do so. This will therefore stop the reproduction cycle of these insect pests.



Let's Think About This

What do you think are the limitations of the biological control method of pest control? Do you think it can eliminate the population of insect pests? Explain your answer.

Compare your answers with those in the *Answer Key* on page 49.



Let's Read

Let us continue with the story of Mike and his Uncle Juan. Mang Juan has advised Mang Teban and Mang Roger to combine the use of pesticides with environment-friendly methods of pest control. Let us see what happens

But how do we combine the use of pesticides with environment-friendly pest control methods? We do not know how to do this thing you call "integrated pest control approach."

There are many possible ways of combining methods of pest control. One combination is the planting of pest-resistant crop varieties and then using a special insecticide that kills only the pests without harming the good insects.

Wow, I never thought there was such an effective method. Can you give more examples of the integrated pest control approach?

Sure, Mang Roger. Heavy infestation of pests can be controlled by chemical spraying followed by the sterile-insect technique. This has been successful in combating a certain kind of aphid (an insect pest).

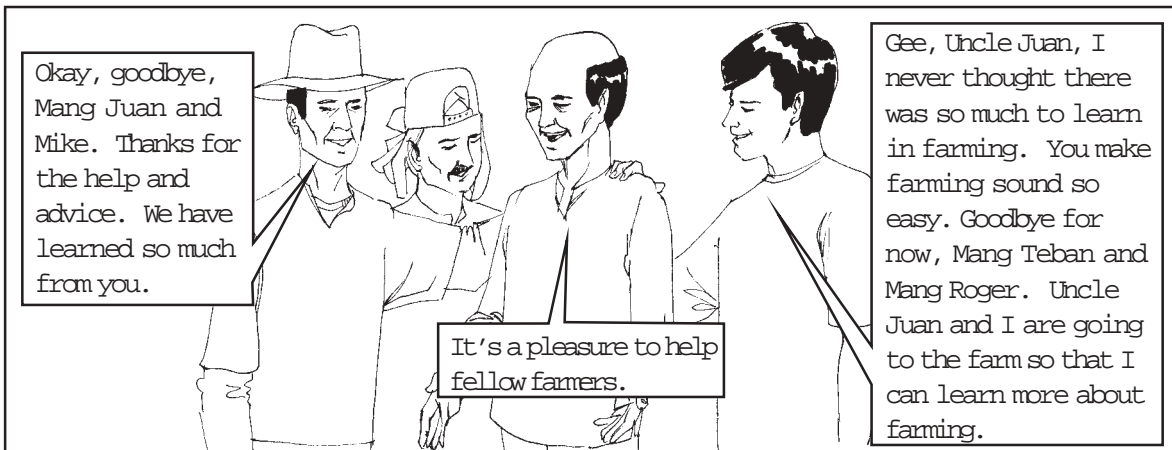

Let's Review

Answer the questions below about what you have just read.

1. What is the integrated pest control approach?

2. Why is the integrated pest control approach more effective and environment-friendly?

Were you able to answer the questions? I'm sure you were. Now compare your answers with those in the *Answer Key* on page 49 to see if they are correct.

If your answers are similar to the ones given in the *Answer Key*, very good! You have understood the integrated pest control approach.

If your answers are different from those in the *Answer Key*, I suggest you review this section of the lesson, because this concept is very important.



Let's See What You Have Learned

Finally, we are about to end the second lesson. We will now see how much you have understood from the topics we have discussed here. Answer the following test questions. Good luck!

1. Can large swarms of insect pests be eliminated through the continuous use of pesticides? Explain your answer. (3 points)

2. What are organophosphate pesticides? Why are they favored over persistent and permanent pesticides? (3 points)

3. Differentiate companion crops and antagonistic crops. Give examples. (3 points)

4. What are some of the insects that help destroy insect pests? (3 points)

Okay, so you're done with the test. Did you find the questions easy? Let's check how well you did. Compare your answers with those in the *Answer Key* on pages 49–50. If your total test score is:

- 10 – 12 Excellent! You have understood the lesson well. You may now continue with the next one.
- 7 – 9 Good! Study only the items in the lesson that you were not able to answer correctly.
- 4 – 6 Review the parts of the lesson which you did not understand.
- 0 – 3 You should study this lesson again.



Let's Remember

- ◆ Pesticides are chemicals used to kill harmful insects, weeds and fungi that harm or destroy plant crops.
- ◆ The use of nonpersistent pesticides, such as synthetic organic chemicals and plant extracts, is much safer and more environment-friendly than the use of persistent and permanent pesticides.
- ◆ Relying on chemical pesticides alone to control pests causes heavy damage on the environment.
- ◆ Relying on environment-friendly methods alone to control pests is not very effective.
- ◆ The integrated pest control approach uses a combination of pesticides and environment-friendly methods to control pests. The integrated pest control approach reduces the use of harmful chemical pesticides that affect the environment and people.

I congratulate you for finishing the first two lessons of this module. You have done a good job! Now you have understood another important requirement for maintaining healthy, pest-free plants. Continue with your study. Turn to the next page for Lesson 3.

Making Your Vegetable Garden

You have learned all about soil fertilization and pest control in the two previous lessons. Now you are ready to make your own vegetable garden. In Lesson 3 you will learn how to do this.

After studying this lesson, you should be able to:

- ◆ discuss the importance of a seedling box;
- ◆ grow seedlings in a seedling box;
- ◆ prepare a garden plot;
- ◆ tell what *mulch* is and how to use it in the garden;
- ◆ determine the right season for planting crops; and
- ◆ apply crop rotation and companion cropping to your vegetable garden.



Let's Read

Let us continue with the story of Mike and his Uncle Juan as they go to the farm to learn more about planting vegetables



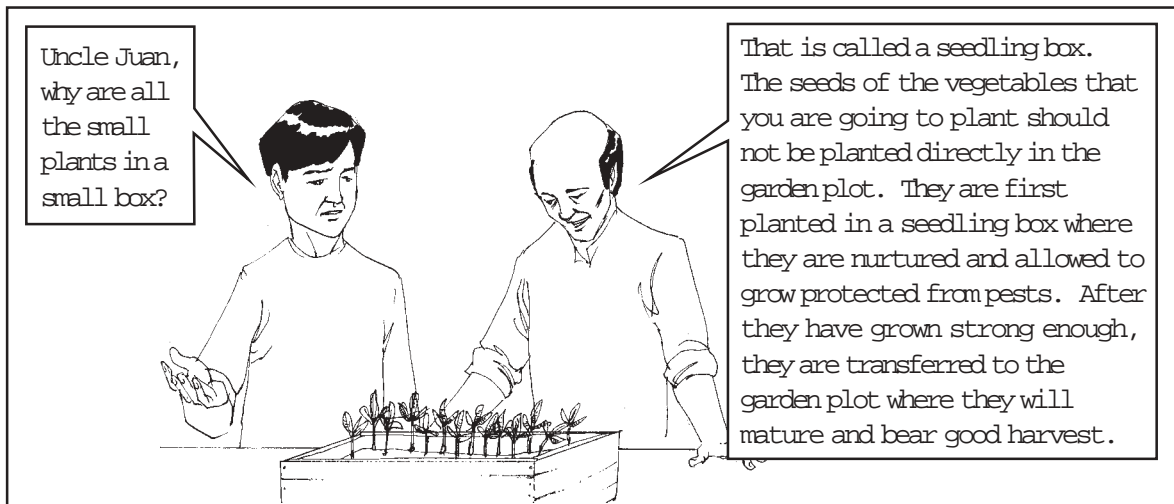

Let's Review

Why do we need to plant the seeds in a seedling box and not directly in a garden plot?

Compare your answer with that in the *Answer Key* on page 50.



Let's Try This

The Seedling Box

You will need the following for this activity:

- ◆ wooden boards or bamboo sticks
- ◆ soil and compost
- ◆ sand
- ◆ tomato seeds
- ◆ ruler or meterstick

Preparing the Seedling Box

We will make a seedling box from wooden boards or bamboo sticks. The seedling box should be about 7 centimeters high, 30 centimeters wide and 45 centimeters long.

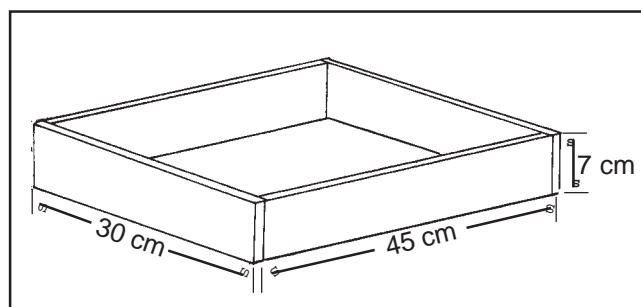

If you are going to use wooden boards, put small holes at the bottom of the box to allow water to drain when you water the seedlings. If you want to use bamboo sticks, put spaces in between the sticks at the base of the box for the water to drain.

Place a layer of sand in the seedling box at least 2 centimeters thick from the bottom of the box. Then fill the box with a mixture of soil and compost. Water the soil in the seedling box.

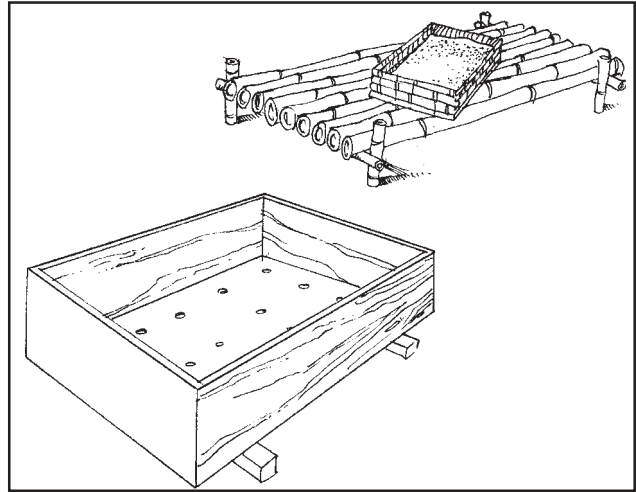

Planting in the Seedling Box

With the use of a small stick, dig rows of holes 1-centimeter deep and 10 centimeters apart. Put a tomato seed on each hole and cover it with soil. Place the seedling box away from direct sunlight and from possible pests that may harm the seeds or seedlings. You may cover the seedling box with a nylon net to protect the seedlings from pests.

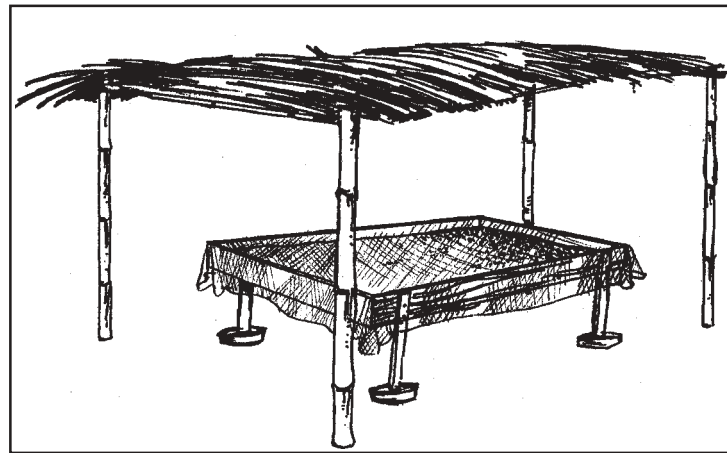

Why do you think the seedling box should be placed away from direct sunlight? Don't plants need sunlight for them to grow? What do you think will happen to the seedlings if they are left under the heat of direct sunlight the whole afternoon?

Water the seedling box every morning and wait for the seeds to sprout and grow until they reach a height of about 10 centimeters. The seedlings are now ready to be transferred to the garden plot.

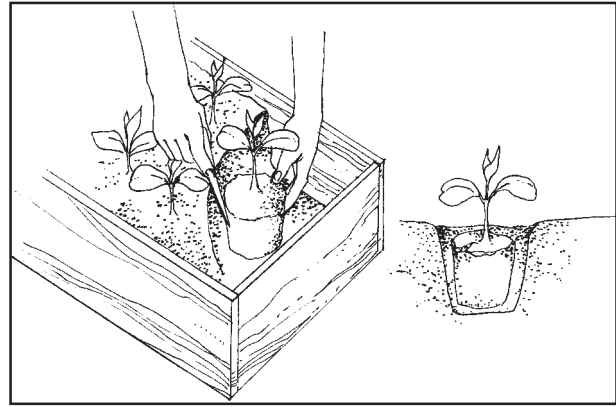

Let's Review

Answer the following questions.

1. Why do you need to cover the seedling box with a nylon net?

2. Why shouldn't the seedling box be placed in direct sunlight?

3. Why should the seedlings be planted with proper spacing?

Compare your answers with those in the *Answer Key* on page 50.



Let's Read

Let us continue with the story of Mike. He has already learned how to plant in a seedling box. But he still has a lot to learn....

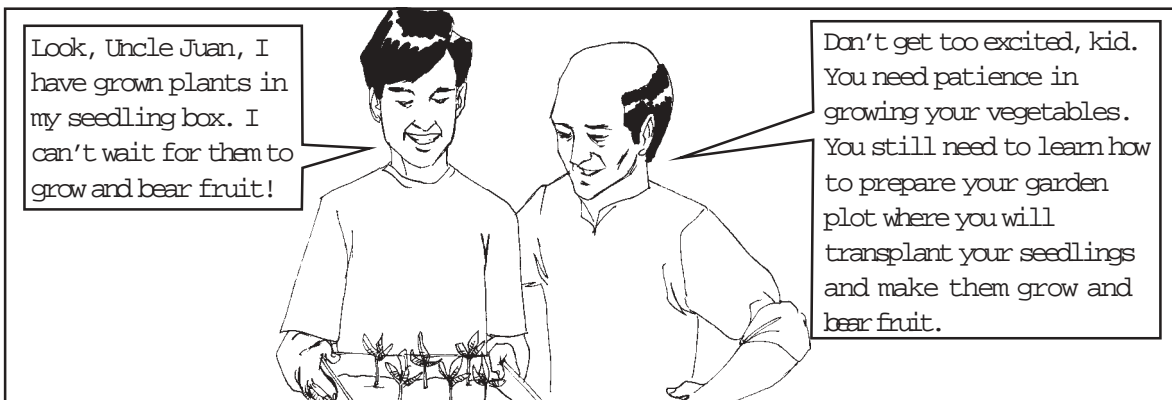

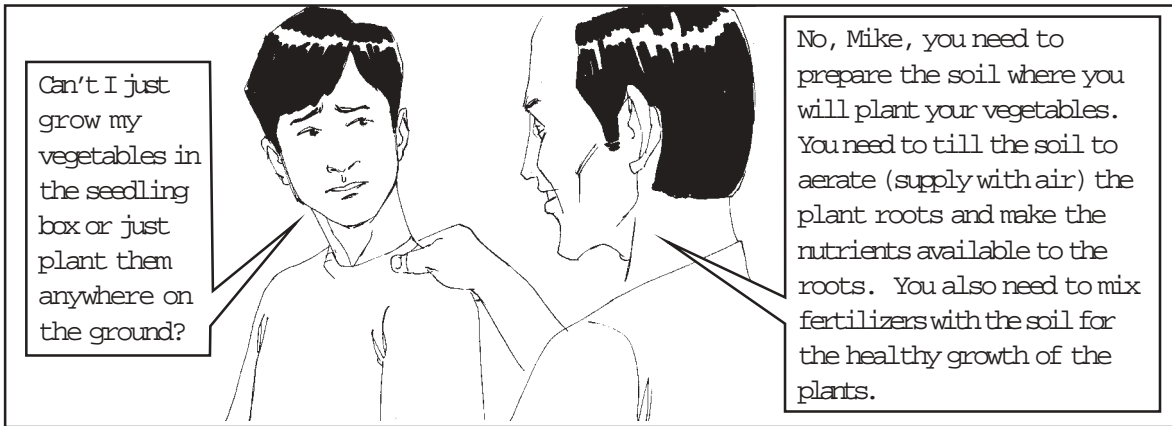

Let's Review

Why can't you just plant your vegetable crops anywhere on the ground?

Compare your answer with that in the *Answer Key* on page 50.



Let's Try This

Making a Garden Plot

You will need the following materials for this activity:

- ◆ meterstick
- ◆ wood marker
- ◆ compost
- ◆ hoe
- ◆ rake

Look for some idle land in your backyard. Using the meterstick, measure a rectangular plot with a length of about 6 meters and a width that won't exceed (be more than) 1.5 meters. Mark the corners of the rectangular plot so that you will know the borders of your plot.



If your plot is 2 meters wide, do you think you can take care of all your plants well? Can you cultivate and water those in the middle?

Next, till the soil with the use of a hoe. This will loosen the soil and break up the hardened parts. Put compost and chemical fertilizers evenly on the plot. Till the plot with the hoe again to mix the fertilizers with the soil. Rake the plot afterward to further break up the hardened soil into smaller pieces. Your garden plot is now ready. You may now transplant the grown seedlings into your garden plot.



Let's Review

Answer the questions below.

1. What is the use of the hoe and the rake for your garden plot?

2. Why do you think the width of the plot should not be more than 1.5 meters?

3. Why do you think vegetables grow best in a garden plot?

Compare your answers with those in the *Answer Key* on pages 50–51.



Let's Read

Let us see what Mike is up to, now that he has learned how to make a garden plot

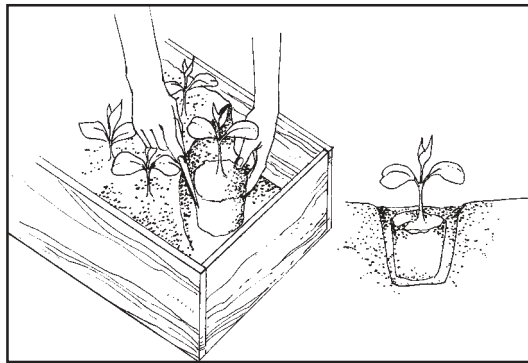
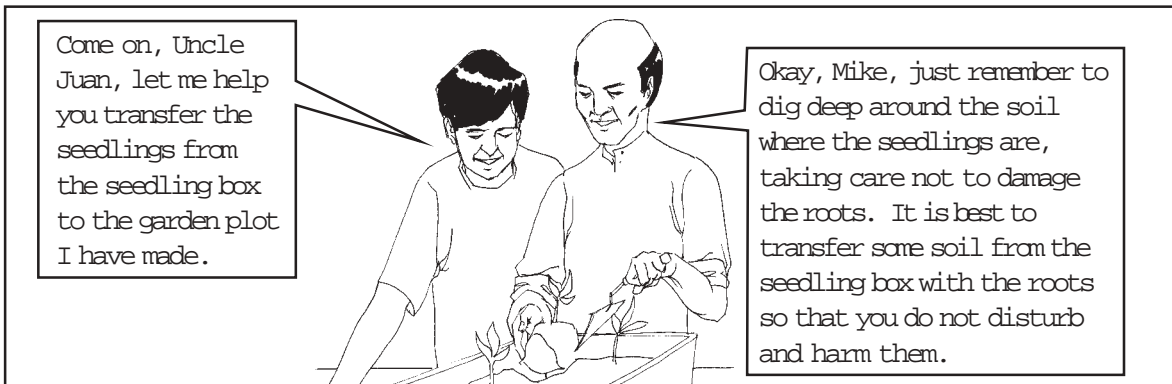

After Mike and Uncle Juan have transplanted the seedlings

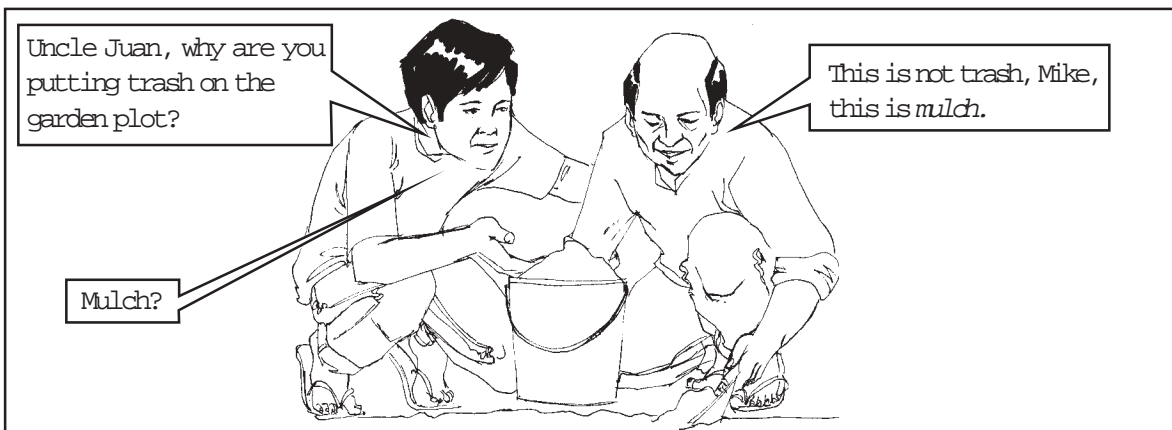

“**Mulch** is made of biodegradable matter such as grass cuttings, manure, bits of newspaper and dead leaves. The purpose of the mulch is to protect the soil from erosion, moisture loss, and too much heat from the sun. It can also serve as organic fertilizer for the plants. Mulch also prevents the weeds from growing with the vegetable plants. You just cover the surface of the soil with these biodegradable materials. This method is called **mulching**.”

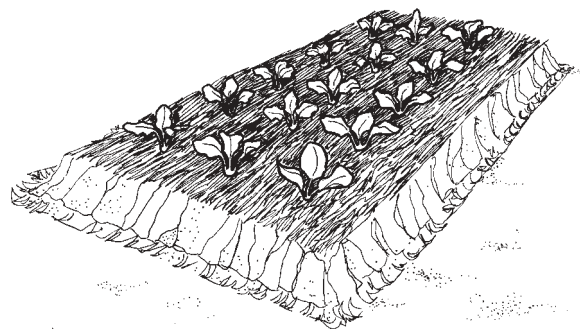



Let's Review

Answer these questions.

1. How do you transfer seedlings from the seedling box to the garden plot?

2. What is mulch? What is it used for?

Compare your answers with those in the *Answer Key* on page 51.



Let's Read

Let us continue with the story of Mike and Uncle Juan as they discuss the seasons for planting

<p>Finally, Uncle Juan, I will be able to raise my own vegetable garden. I intend to apply crop rotation and companion cropping in my small garden. But I don't know what crops to plant at a specific time or season. Aren't there seasons for planting certain vegetables?</p>		<p>You are right, Mike. Most farmers here in the Philippines plant certain vegetables on specific months. They obtain plentiful harvests that way. Certain plants thrive and grow very well during certain seasons. Here, I'll show you a chart about the right season for planting common vegetables</p>
--	--	--

Uncle Juan took a book and showed this chart to his nephew:

Season for Planting Certain Vegetables in the Philippines

Vegetable	Jan	Feb	Mar	Apr	May	Jun	Ju
<i>Bataw</i>				*	*	*	*
Beet	*						
Bell Pepper	*				*	*	
Bitter gourd (<i>Ampalaya</i>)	*	*	*	*	*	*	*
Cabbage	*	*	*				
Carrot	*						
Cassava plant	**	**	**	**	*	*	**
Cauliflower	*	*	*				
Corn	*	*	*	*	*	*	
Cucumber	*	*		*	*	*	*
Eggplant	*	*		*	*	*	
Garlic and Onion	*						
Lettuce	*	*	*	*	*	*	
Lima beans (<i>Patani</i>)	**			*	*	*	*
Melon	*	*					
Munggo beans	*	*	*	*	*	*	*
Mustard	*	*		*	*	*	
Okra	*			*	*	*	
Patola	*	*		*	*	*	
Pechay	*	*		*	*	*	
Radish	*	*		*	*	*	
<i>Sayote</i>	*				*	*	**
<i>Sigarilyas</i>	**	**	**	*	*	*	**
Squash	*	*		*	*	*	
String beans (<i>Sitaw</i>)	*	*		*	*	*	*
Sweet potato	*	*	*	*	*	*	*
Tomato	*	*	**	**	**	**	**
<i>Tubers (Cabi)</i>	**	**		**	*	*	*

* A single asterisk means that most farmers in the Philippines plant during these months.

** A double asterisk means that these plants can be planted if you are located in Central Luzon or in other provinces where the climate is similar. Some provinces where these crops may be grown during these months are Bataan, Batangas, Tarlac, Ilocos Sur, Ilocos Norte, La Union, Nueva Ecija, Pampanga, Pangasinan, Rizal and Zambales.



Plan for Rotating Crops in One Year

Crop Rotation Plan	Planting	
	First	Second
1	Leafy	Fruit Bearing
2	Fruit Bearing	Leafy
3	Root Crops	Legumes
4	Legumes	Root Crops

Examples of Vegetables Under Each Classification

Leafy	Fruit Bearing	Legumes
Cabbage	Tomato	String Beans
Horseradish	Cucumber	Peanuts
Lettuce	Eggplant	Munggo beans
Pechay	Okra	Baguio beans

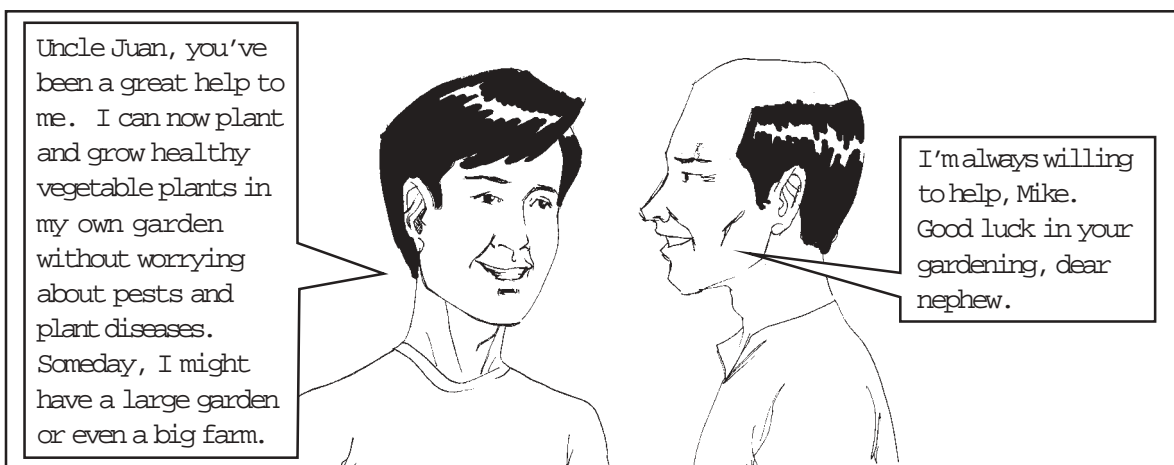



Let's Review

A. Based on what you have read, answer the following questions.

1. From the table given on page 38, list down the vegetables that should not be planted during the month of April.

2. During what months can squash be planted?

3. During what months should eggplants not be planted?

4. Using the tables on crop rotation on the previous page, select four vegetables for crop rotation using Plan #2. Write them in the blanks provided.

d. _____

a. _____

b. _____

c. _____

B. Classify the vegetables below. Tell whether they are *leafy*, *legumes*, *root crops* or *fruit bearing*.

- _____ 1. Squash
- _____ 2. Cassava plant
- _____ 3. Lima beans
- _____ 4. Mustard
- _____ 5. Garlic
- _____ 6. Corn

Compare your answers with those in the *Answer Key* on page 51.



Let's See What You Have Learned

At last, we have come to the end of Lesson 3. Congratulations for making it this far. All you have to do now is prove that you have learned well from this lesson. Take the test below. Good luck!

- 1) Why do farmers plant certain vegetables during certain months only? (4 points)

- 2) What is mulch? What is it used for? (4 points)

- 3) Explain the importance of a garden plot. (4 points)

- 4) Explain the process of planting in a seedling box until the seedlings are ready to be transplanted to the garden plot. (4 points)

That was an easy test, wasn't it? Now let's check how well you did. Compare your answers with those in the *Answer Key* on pages 51–52. If your total test score is:

- 13 – 16 Excellent! You have understood the lesson well. You are a good learner. You have successfully finished all three lessons of this module. You are now ready to make your own vegetable garden.
- 9 – 12 Good! Study only the items in the lesson that you did not get right.
- 5 – 8 Review the parts of the lesson which you did not understand.
- 0 – 4 You should study this lesson again.



Let's Remember

- ◆ Most plant seedlings should be grown in a seedling box to protect them from pests and harmful elements.
- ◆ Making a garden plot will improve the soil where the vegetables will be planted. This will result in healthier plants, which means a pest-free garden and richer harvests.
- ◆ Mulching improves the condition of the soil, keeps soil moisture, prevents weeds from growing and provides fertilizer for the plants.
- ◆ Vegetable plants should be planted during the right season to increase crop harvest.
- ◆ Using crop rotation and companion cropping will improve the soil condition, produce better harvest and keep pests away from your garden.



Let's Sum Up

Below are the important points discussed in the module. Remember them when preparing your own garden.

- ◆ The use of both organic and chemical fertilizers will provide the plant crops with most of the essential nutrients.
- ◆ The integrated pest control approach reduces the use of harmful chemical pesticides that affect the environment and people.
- ◆ Most plant seedlings should be grown first in a seedling box to protect them from pests and harmful elements.
- ◆ Making a garden plot will improve the soil where the vegetables will be planted.
- ◆ Mulching improves the condition of the soil, keeps soil moisture, prevents weeds from growing and provides fertilizer for the plants.
- ◆ Vegetable plants should be planted during the right season to increase crop harvest.



What Have You Learned?

Congratulations, you have finished studying the module. You may now use your knowledge to grow healthy and pest-free vegetable plants in your garden.

But before we end this module, let us determine how much you have really learned from the lessons. Answer the following test.

- _____ 1. Which of the following insects helps control pests?
 - a. grasshopper
 - b. praying mantis
 - c. locust
 - d. caterpillar
 - e. none of the above

- _____ 2. Which among the following is *not* an essential nutrient for plants?
 - a. phosphorus
 - b. nitrogen
 - c. aluminum
 - d. potassium
 - e. none of the above

- _____ 3. Which of the following is an ingredient for making mulch?
- a. stones
 - b. plastic wrappers
 - c. styrofoam
 - d. grass cuttings
 - e. all of the above
- _____ 4. Which of the following is *not* a vegetable classification?
- a. leafy
 - b. legumes
 - c. root crops
 - d. fruit bearing
 - e. none of the above
- _____ 5. Which among the following pesticides is the least harmful?
- a. DDT
 - b. pesticides containing mercury
 - c. organophosphate pesticide
 - d. heptachlor
 - e. none of the above
- _____ 6. Which of the following is not a pesticide?
- a. parricide
 - b. insecticide
 - c. herbicide
 - d. fungicide
 - e. none of the above
- _____ 7. Which of the following is not an environment-friendly method of pest control?
- a. use of crop rotation
 - b. breeding friendly insects
 - c. inter-cropping with aromatic herbs
 - d. use of fertilizers
 - e. none of the above
- _____ 8. Which soil type will produce the healthiest corn plant?
- a. sand
 - b. mixture of sand and compost
 - c. mixture of sand, compost and chemical fertilizer
 - d. sand and chemical fertilizer
 - e. all of the above

- _____ 9. What should be the maximum width of a garden plot?
- a. 10 meters
 - b. 10 inches
 - c. 1.5 meters
 - d. 1.5 feet
 - e. none of the above
- _____ 10. Which among the following is *not* a characteristic of compost?
- a. It holds and keeps the nutrients and minerals in the topsoil for plants to use.
 - b. It supports soil bacteria or microorganisms that maintain the plants.
 - c. It holds water or moisture in the soil.
 - d. It improves the characteristics of the soil and allows air to go to the plant roots.
 - e. none of the above

11 – 13. What is the integrated pest control method and what are its advantages? (3 points)

14 – 15. Why do we need to combine the use of organic and chemical fertilizers? (2 points)

Compare your answers with those in the *Answer Key* on pages 52–53.

If your score is :

- 13 – 15 Excellent! You have understood this module very well. You may now study the next one.
- 9 – 12 Good! Review the items which you did not get right.
- 5 – 8 Review the lessons which you did not understand.
- 0 – 4 You have to study this module again.



Answer Key

A. Let's See What You Already Know (page 2)

1.
 - a. **H** Caterpillars eat the leaves of crops.
 - b. **F** Lizards eat the harmful insects.
 - c. **H** Grasshoppers eat the leaves of crops.
 - d. **F** Earthworms help decompose organic matter and aerate the soil.
 - e. **H** Locusts eat the leaves of crops.
2. A seedling box is needed to allow the seeds to grow well-protected from harmful elements and from pests.
3.
 - a. }
 - b. } phosphorus, potassium, nitrogen
 - c. }
4.
 - a. **I** Chemical fertilizers are needed to provide the plants with nutrients that organic fertilizers can't provide.
 - b. **I** Carbohydrates and fats are not plant nutrients.
 - c. **I** Crop rotation should be used so that soil nutrients will not be easily exhausted; this also prevents pest infestation.
 - d. **I** Sometimes it is unavoidable to use pesticides to control pest infestations, although their use should be minimized and combined with alternative methods of pest control.
 - e. **I** Vegetables should be planted during the right season to increase crop harvest.

B. Lesson 1

Let's Review (page 9)

1. Dig a pit in the ground.
2. Put some plant wastes, i.e., grass cuttings, dead leaves, vegetable peelings, food leftovers, etc.
3. Then add some animal waste (manure).
4. Add a layer of soil to the compost pile.
5. Alternate layers of plant wastes, animal wastes and soil.
6. Wait for about 3 months and then your compost is ready.

Let's Study and Analyze (pages 11–12)

1. Pot 2 is the most complete in plant nutrients. It has compost and chemical fertilizers. The compost provides nitrogen, organic matter and soil bacteria needed by the plants. The chemical fertilizer supplies the plant with potassium and phosphorus, which are lacking in compost. The soil mixture is therefore favorable for healthy plant growth.
2. Pot 4 is the most lacking in plant nutrients. The few minerals (nutrients) found in the sand are not readily available to the plants. Sand cannot hold the plant nutrients and the water very well. The plant nutrients nitrogen, potassium and phosphorus are lacking in sand.
3. The nutrients provided by the chemical fertilizer in Pot 3 can easily be lost because of the absence of compost or organic matter. Compost and organic matter hold the plant nutrients in the soil very well, making them available to plants. Sand cannot hold the plant nutrients very well.
4. The corn planted in Pot 2 will grow the healthiest because the soil mixture in this pot is complete in plant nutrients. The soil holds the nutrients and water well for them to be available to plants.

Let's Review (pages 13–14)

1. According to Mang Juan, chemical fertilizers rich in potassium and phosphorus should be combined with organic fertilizers. The organic fertilizer already provides the plant nutrient nitrogen. This way, the three important plant nutrients are available to the plants.
2. The plant nutrient potassium can be derived from potash rocks or granite dust. The plant nutrient phosphorus can be derived from phosphate rocks or animal bones. Phosphorus is also available in supply houses as *superphosphate*.
3. No. Even if chemical fertilizers provide the three important plant nutrients, organic fertilizers are still needed. The organic fertilizer is important because it holds the nutrients and water in the soil, ready for plants to use. Organic fertilizer also provides soil bacteria that break down the minerals and other organic matter in the soil which are not readily available to plants.

Let's See What You Have Learned (page 14)

1. Chemical fertilizers can provide the three important plant nutrients: nitrogen, phosphorus and potassium. But if organic fertilizers are not used, the organic matter in the soil might be used up. Organic matter is used to hold water and plant nutrients in the soil. If the chemical fertilizers are not held in the soil, they might go to nearby bodies of water and poison the fish and other animals that live within or near the area.

2. Compost is made by digging a pit in the ground, then putting alternate layers of plant waste, animal waste and soil. The mixture is then left to decompose for three months before it is ready for use.
3. Compost provides the soil with the nutrient nitrogen. It also provides organic matter needed to hold water and nutrients in the soil for the plants to use. Compost also provides soil bacteria that break down organic matter and soil minerals to make them available as nutrients for plants.
4. This is a sample answer. You may have a different opinion about the issue:

There is nothing wrong with farmers who support organic farming. I think that their cause is good because by not using chemical fertilizers, they prevent the possibility of polluting nearby bodies of water with chemicals that may harm the fish. Their farm may not be as productive though, because of the lack of potassium and phosphorus that are needed by the crops.

C. Lesson 2

Let's Review (page 20)

1. A large swarm of pests attacked Mang Teban's farm because many of the natural enemies of the pests have been eliminated due to the use of pesticides. The pests may have also developed resistance against the pesticides because of Mang Teban's frequent use of pesticides.
2. Any five among these: frog, lizard, ladybug, praying mantis, dragonfly, spider.
3. The balance of nature allows some of the pests to survive so that the good insects and animals will have something to eat. These pests that survive can destroy Mang Roger's farm to some extent. Therefore, other pest control methods should be employed to fight the pests.

Let's Think About This (page 21)

1. Nonpersistent pesticides easily decompose into harmless substances. This way, there is minimal environmental damage. Poisonous residues do not remain unlike in persistent and permanent pesticides. Permanent and persistent pesticides leave harmful residues on the farm and on the vegetables and fruits which we eventually eat.
2. There are three different kinds of pests: weeds, insect pests and fungi. We therefore need herbicides for the weeds, insecticides for the insect pests and fungicides for the fungi. We need different pesticides to eliminate different pests.

Let's Think About This (page 22)

The mechanical method of pest control is more effective in small farms where the supervision of pest infestation is easier. Large farms are more problematic and mechanical control methods may not be practical and effective.

Let's Think About This (page 24)

1. Fertilizers can make the crops healthy and therefore resistant to pest infestation. Crops that lack plant nutrients are prone to pests. This way, the application of fertilizers is a method for pest control.
2. There are companion crops or different kinds of plants which can be planted together. But there are also plants called antagonistic crops which, when planted together, may weaken their resistance to pest infestation. Therefore, not all plants can be planted together.

Let's Think About This (page 26)

The biological method of pest control, like the breeding of good insects that will prey upon the insect pests, has its limitations. This method can reduce the population of insect pests but the balance of nature will allow some insect pests to survive. These insect pests that do survive can still do some damage to farms.

Let's Review (page 27)

1. The integrated pest control approach uses both pesticides and environment-friendly methods of pest control. It aims to effectively reduce or eliminate pests in the garden while minimizing the damage to the environment brought about by the use of chemicals.
2. The integrated pest control approach combines the effectiveness of pesticides and environment-friendly methods of pest control. It also minimizes the use of pesticides; that is why it is more environment-friendly. It makes use of a combination of biological, cultural, mechanical and chemical methods to control pests. Combinations are more effective than just applying a single method for pest control.

Let's See What You Have Learned (page 28)

1. The continuous use of pesticides cannot eliminate large swarms of insect pests. It can, in fact, induce the pests to multiply to a large number since the continuous use of pesticides harm the good insects which keep the number of insect pests in check.
2. Organophosphate pesticides are organic chemicals usually made from plant extracts. They are favored because they easily decompose into harmless substances unlike the persistent and permanent pesticides, which leave harmful residues in the farm for years.

3. Companion crops are crops which can be planted together because they do not compete with each other for plant nutrients. Most companion crops repel the pests of their companion crop. Examples of companion crops are onion and tomato, potato and carrot and lettuce and cucumber. Antagonistic crops compete with each other for nutrients in the soil and attract the same kind of pests. Examples of antagonistic crops are potato and cucumber and beans and onion.
4. Some of the insects which help destroy insect pests are praying mantises, spiders, ladybugs and dragonflies.

D. Lesson 3

Let's Review (page 31)

Seeds should be planted in a seedling box to protect the young plants or seedlings from harmful elements and pests during their most critical stage of growth. They are exposed to more danger if they are planted directly in the garden plot.

Let's Review (page 33)

1. The nylon net provides protection for the seedlings from pests that may harm them.
2. Direct sunlight is too hot for the seedlings to bear. It may harm or even kill these young plants. That is why the seedling box should be placed in a shaded area away from direct sunlight.
3. Seedlings should be planted with proper spacing so that the seedlings don't compete with one another for plant nutrients. The roots of the seedlings may also get entangled if they are planted too close to one another. This may be a problem when transferring the seedlings to the garden plot.

Let's Review (page 34)

A garden plot should be prepared when planting vegetables. The soil in a prepared garden plot is free of weeds, properly fertilized and tilled. These conditions will improve the harvest of the vegetables planted in the garden plot.

Let's Review (page 35)

1. The hoe is used to break down the hardened soil. The rake is used to further break down the large pieces of hard soil that the hoe was not able to break down.
2. The width of the garden plot should not exceed 1.5 meters or else it will be difficult to water the plants near the center of the garden plot. It may also be difficult to reach the center part of the plot, which may need to be handled.

3. Vegetables will grow best in a garden plot because the soil in the plot is well prepared for the healthy growth of the plants. Soil is broken down to small pieces so that the nutrients in the soil are readily available for the plants and so that the roots can be aerated. Soil in the plot is also enriched with fertilizers.

Let's Review (page 37)

1. Dig deep around the base of the seedling, allowing some soil to be transferred along with the roots but taking care not to damage the roots. Put the seedling in a previously dug portion of the garden plot and cover it with more soil.
2. Mulch is made of biodegradable materials like grass cuttings, manure and dead leaves. It is used to protect the soil from erosion, moisture loss and too much heat from the sun. It also provides organic fertilizer for the vegetable plants. Mulch also prevents the growth of weeds.

Let's Review (page 40)

- A.
1. These are the vegetables which should not be planted during the month of April: beet, bell pepper, cabbage, carrot, cauliflower, garlic, onion, melon, *sayote* and *upo*.
 2. Squash can be planted during the months of January, February, April, May, June, September, October, November and December.
 3. Eggplants should not be planted during the months of March and July.

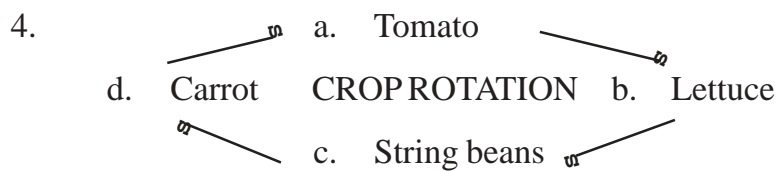

- B.
1. fruit bearing
 2. root crop
 3. legumes
 4. leafy
 5. root crop
 6. fruit bearing

Let's See What You Have Learned (page 41)

1. Farmers plant certain vegetables preferably during months when the season is favorable for their growth. Seasons or climatic conditions change during different months, so farmers keep track of the months when vegetables should be planted.

2. Mulch is made up of biodegradable materials such as grass cuttings, cut-up pieces of newspapers and animal manure. Mulch is used as garden plot cover to prevent weeds from growing and to keep soil moisture. It also acts as a fertilizer for the plants.
3. A garden plot is needed to plant vegetables. In it, the ground is prepared for the proper growth of the plants. In a garden plot, the soil is tilled to aerate the roots of the plants and make the nutrients in the soil available to the roots. Fertilizers are usually mixed with the soil in the garden plot for the healthy growth of the plants.
4. Before planting the seeds in the seedling box, find a place where the seedling box could be placed away from direct sunlight and from possible pests that may harm the seeds or seedlings. Plant the seeds in rows of holes 1-centimeter deep and 10 centimeters apart. Cover the holes with soil after putting the seeds. Water the seedling box every morning and wait for the seeds to sprout and grow until they reach a height of about 10 centimeters.

E. What Have You Learned? (*pages 43–45*)

1. **b** The grasshopper, locust and caterpillar are all pests.
2. **c** The essential plant nutrients are nitrogen, potassium and phosphorus.
3. **d** Grass cuttings are biodegradable, the other choices are non-biodegradable.
4. **e** All are vegetable classifications.
5. **c** DDT, heptachlor and pesticides containing mercury accumulate in farmlands and do more damage, while organophosphate pesticides decompose quickly into harmless substances.
6. **a** Parricide means the killing of a close relative; this is not a pesticide. The other choices are pesticides.
7. **e** All the items are environment-friendly methods of pest control.
8. **c** The complete nutrients plus organic matter are provided in this soil. The other choices have sand that is lacking in essential plant nutrients and organic matter.
9. **c**
10. **e** All the items are characteristics of compost.

- 11 – 13. The integrated pest control approach combines the use of pesticides and environment-friendly methods of pest control. It minimizes the use of pesticides; therefore it is more environment-friendly. It makes use of a combination of biological, cultural, mechanical and chemical methods to control pests. Combinations are more effective than just applying a single method of pest control.
- 14 – 15. We need to combine the use of chemical and organic fertilizers to provide the plants with all the essential nutrients they need for healthy growth and more harvest. Organic fertilizers provide plants with nitrogen, organic matter and soil bacteria. Chemical fertilizers provide the plants with nutrients like potassium and phosphorus.



Glossary

Compost Organic matter made from decomposed materials. It is used as an organic fertilizer.

Crop rotation The farming method of alternating the planting of different kinds of plants (e.g., fruit-bearing, leafy, legumes and root crops).

Fungicide A type of pesticide used to kill fungi.

Herbicide A type of pesticide used to kill insect pests.

Mulch Composed of biodegradable materials used as ground cover to prevent the growth of weeds, keep soil moisture, prevent soil erosion, protect plants from too much heat and provide fertilizer for the plants.

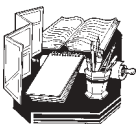

References

Rama, Mario. *Gabay Ng SAMAKA Sa Pagsasaka Sa Bakuran*. Manila: Philippine Charity Sweepstakes Office, 1982.

Raech, Harry. *How to Make Garden Compost*. USA: 1971.

Gwinn, Robert. *The New Encyclopedia Britannica. 15th ed.* Chicago: Encyclopedia Britannica Inc., 1993.

Buena Biosystems. 2000. *Biological Control*. <<http://www.buenabiosystems.com/concept.htm>>. September 9, 2000, date accessed.

